

Instructions



Topan VP6 Verner Panton 1959

Congratulations with your new Topan lamp, designed in 1959 by Verner Panton. We hope you will enjoy using this lamp and follow these instructions to ensure correct installation. If you have any questions or comments, please do not hesitate to contact us by mail on:

info@andtradition.com

Topan VP6 Verner Panton 1959

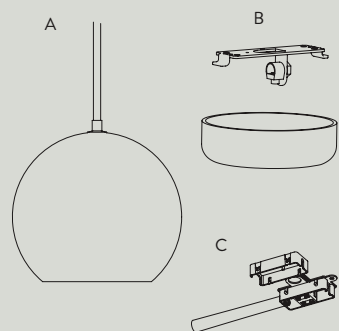

Please read these instructions carefully and retain them for future reference to ensure that the product is used correctly. For your own safety, please study each step of this instruction manual first. &Tradition is not responsible for any faults or damages caused by not following these instructions correctly. Do not modify this product in any way.

Contents

- A Lamp
- B Canopy with metal ceiling bracket
- C Connection box

Tools needed

- Bulb type E27
- Small flat-head screwdriver for wiring

Safety precautions

- Dispose of plastic bag from packaging and do not allow children to play with it.
- Keep product well out of children's reach.
- The lamp is only intended for interior use.
- Lamp exterior gets hot after prolonged use.
- Do not attempt installation of product if you are not competent to do so yourself.
- Consult a professionally qualified electrician if in any doubt.
- Disconnect the electricity supply at the fuse box, before commencing work.
- If the external cable or cord of this lamp is damaged, it must be replaced by the manufacture or a similar qualified person in order to avoid a hazard.

Cleaning instructions

- Wipe surface of lamp shade with a soft, damp sponge or cloth.
- Do not use any abrasive cleaning tools such as steel wool, scouring sponges or stiff brushes.
- Never use strong cleaning agents such as white spirit, terpentine, household glass cleaner or cellulose thinners.
- Only wipe the inside of the shade with a soft, damp cloth or feather duster.

For indoor use only
E27 maximum 30W
Bulb not included

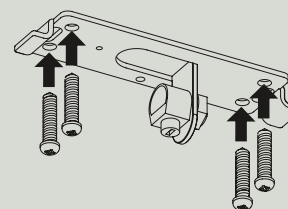

Step 1

Ensure power supply is turned off and remove any existing lamp fitting.
Locate the supply cable and ensure it is ready to be fitted to the connector block.
Mount the metal bracket (B) securely in the ceiling with screws and wall plugs, appropriate for the ceiling of installation.

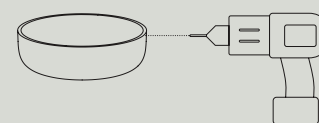

Step 2

Drill a hole into the side of the canopy and pull electric cord through it

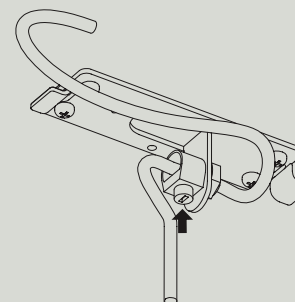

Step 3

To determine the right suspension height for the lamp, pass the electrical cord through the strain relief of the metal bracket (B). When you have the desired suspension height of the lamp, tighten the plastic screw of the strain relief.

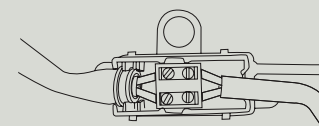

Step 4

Use the terminal box inside the connection box (C) to assemble the wires from the pendant with the wires from the power supply. Close the connection box and place it inside the canopy.



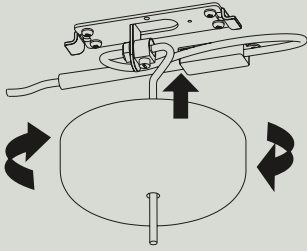

Step 5

Install the plastic canopy onto the metal bracket

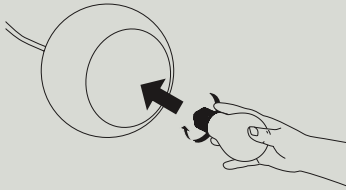

Step 6

Install the light bulb.